

## Ports and Connectors

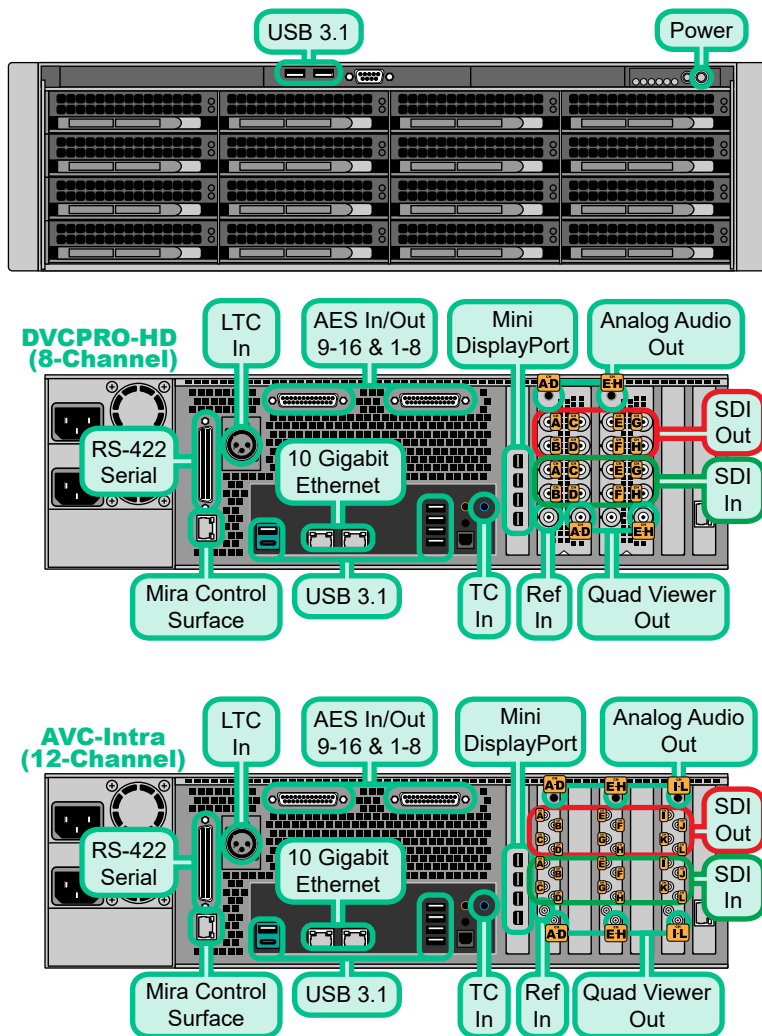

### Notes:

- Only the Reference BNC (Ref In) on the left (Ch A-D) card is operational when more than one card is installed.
- The AES Digital Audio I/O ports require the TASCAM AES DIGITAL DB25 Breakout Cable option (not supplied with system).
- The number of SDI inputs and outputs depends on the model of server you have.
- If you are recording from, or playing into, an external device you must have all devices connected to the same reference signal to ensure proper audio/video synchronization.
- A breakout cable connects to the Serial port and provides 8 RJ45 serial connectors.
- Both RS-422 serial and ethernet control are supported for remote control.
- The TC In (LINE IN) audio port is used for TC Chase.

## Power, Video, Audio and Control Cabling

**Note:** The number of Video I/O cards in your server depends on the options installed. Every video channel features an SDI input and SDI output; and every channel can be used as a recorder or player.

**Note:** An octal breakout cable is supplied with the server and provides 8 RJ45 male connectors for serial control over the first 8 channel transports. RJ45 to D9 adapters are also provided.

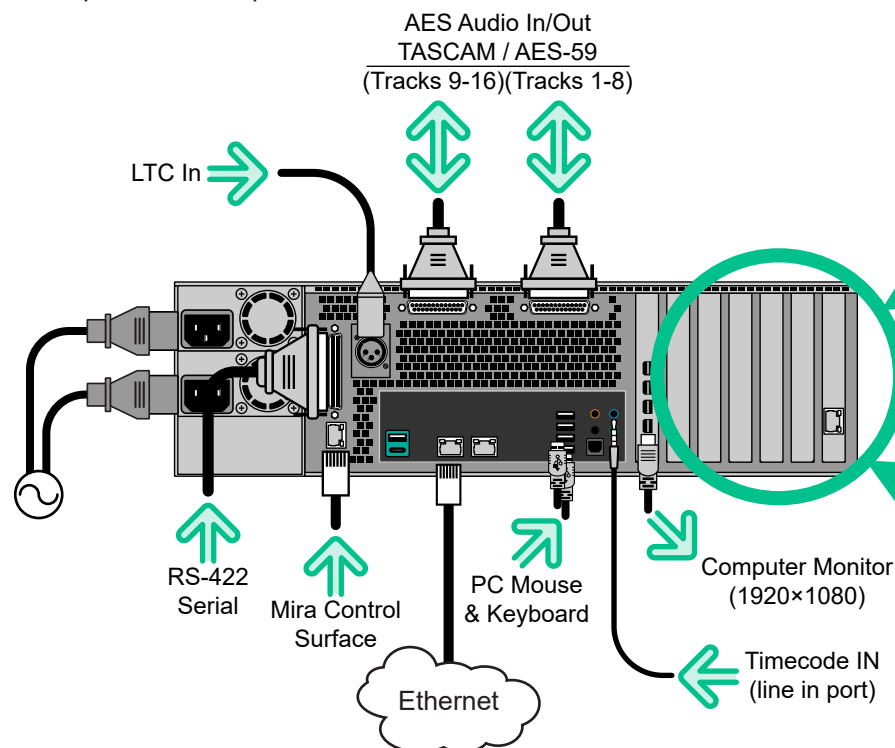

**Note:** It is recommended that you always connect the AC Power Adapter to the device before connecting to Mains Power.

## Specifications

SDI Video Formats	AVC-Intra	DVCPro-HD
525i (480i) 59.94Hz	No	Yes
625i (576i) 50Hz	No	Yes
720p 50/59.94Hz	Yes	Yes
1080i 50/59.94Hz	Yes	Yes
1080p 23.98/24Hz	No	No
1080p 50/59.94Hz	Yes	No
UHDTV1 50/59.94Hz	Yes	No

Default Passwords	
Windows	Abekas
Administrator	multiflex

Input Voltages	
	100 to 240V~
	3 to 1.5A
	60 to 50Hz

Operating Environment	
Temperature:	20 - 35°C (68 - 95°F)
Humidity:	20 - 80%

**Note:** Some video formats require specific hardware to be installed in your server.

## Port Pinouts

### AVC-Intra (12-Channel)

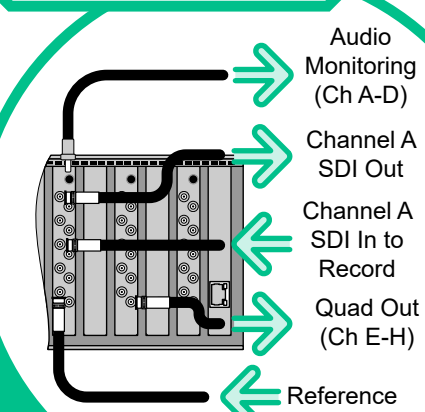

### DVCPro-HD (8-Channel)

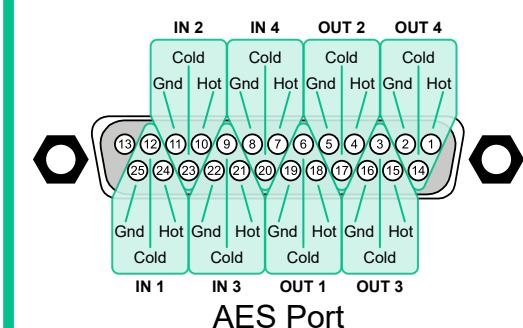
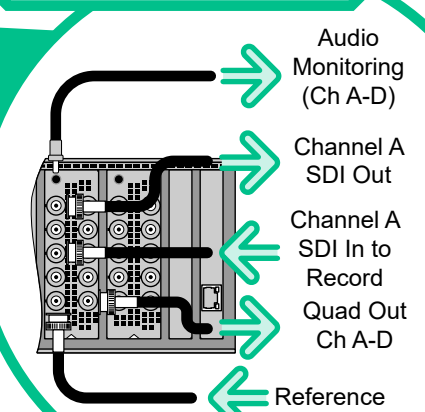

RS422 (RJ45/DB9)	
Pin	Signal
1	Gnd
2	Tx-
3	Rx+
4	Rx Gnd
5	n/c
6	Tx Gnd
7	Tx+
8	Rx-
9	n/c

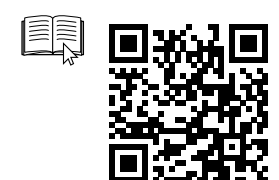



**Caution:** Before you set up and operate your server, see the "Important Safety Instructions" in your User manual.

## User Interface Connection

**Note:** The Mira Control Surface connects to the AVC-Intra and the DVCPRO-HD systems in the same way.

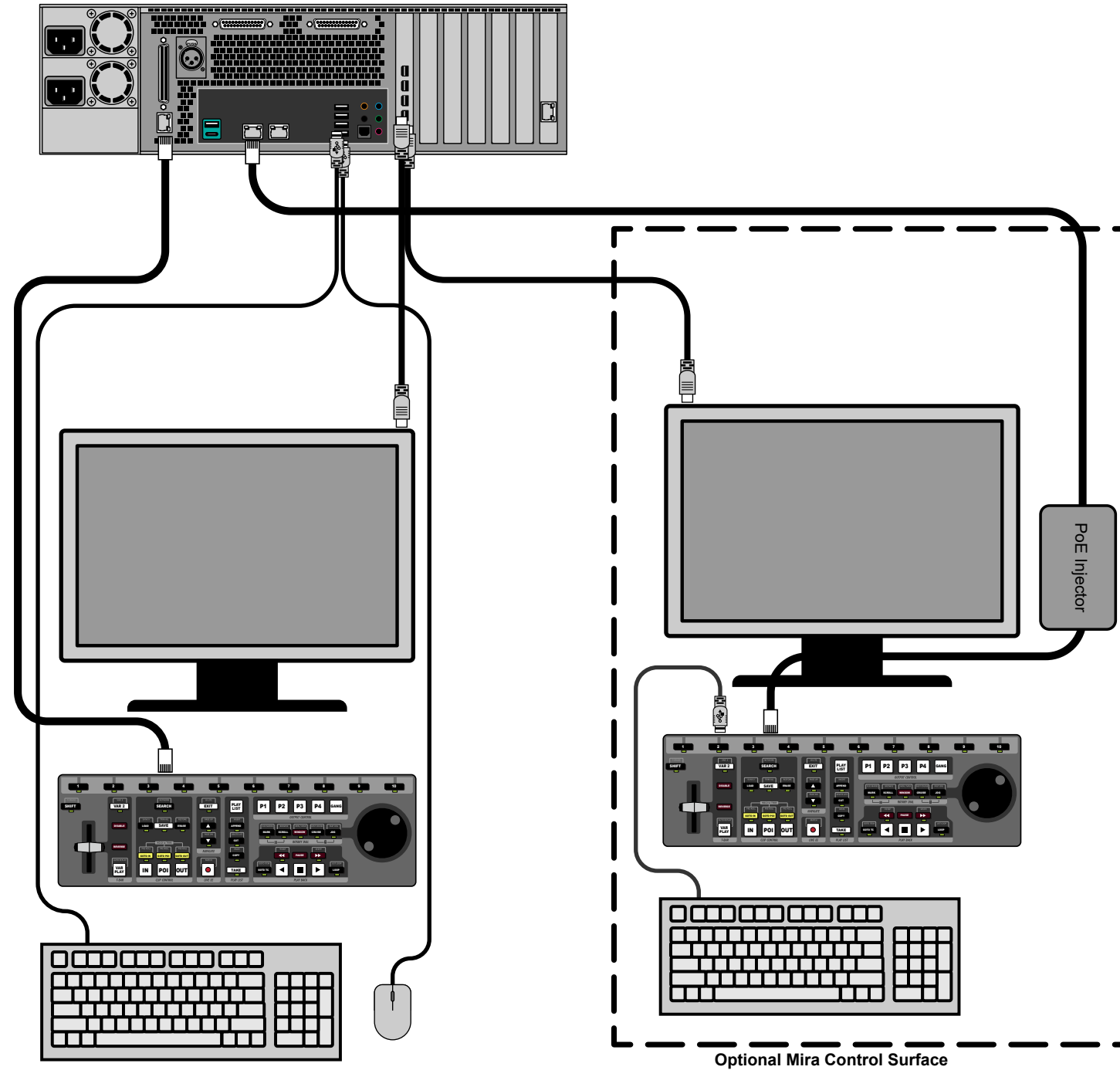

Having a problem? Call our free, 24-hour technical support hotline to speak with a live product specialist located right here in our facility.

Tel: (+1) 613 • 652 • 4886

Email: [techsupport@rossvideo.com](mailto:techsupport@rossvideo.com)